

3119001

Whelen 4000 KKKFS (85")

RS RR RR CS RR RR RS

94"

Air Horns

Type I 1480	Date: 6/3/99
Body # 3119 - 3123	
Marque, Inc. - Goshen, IN	
Exterior View-Front	

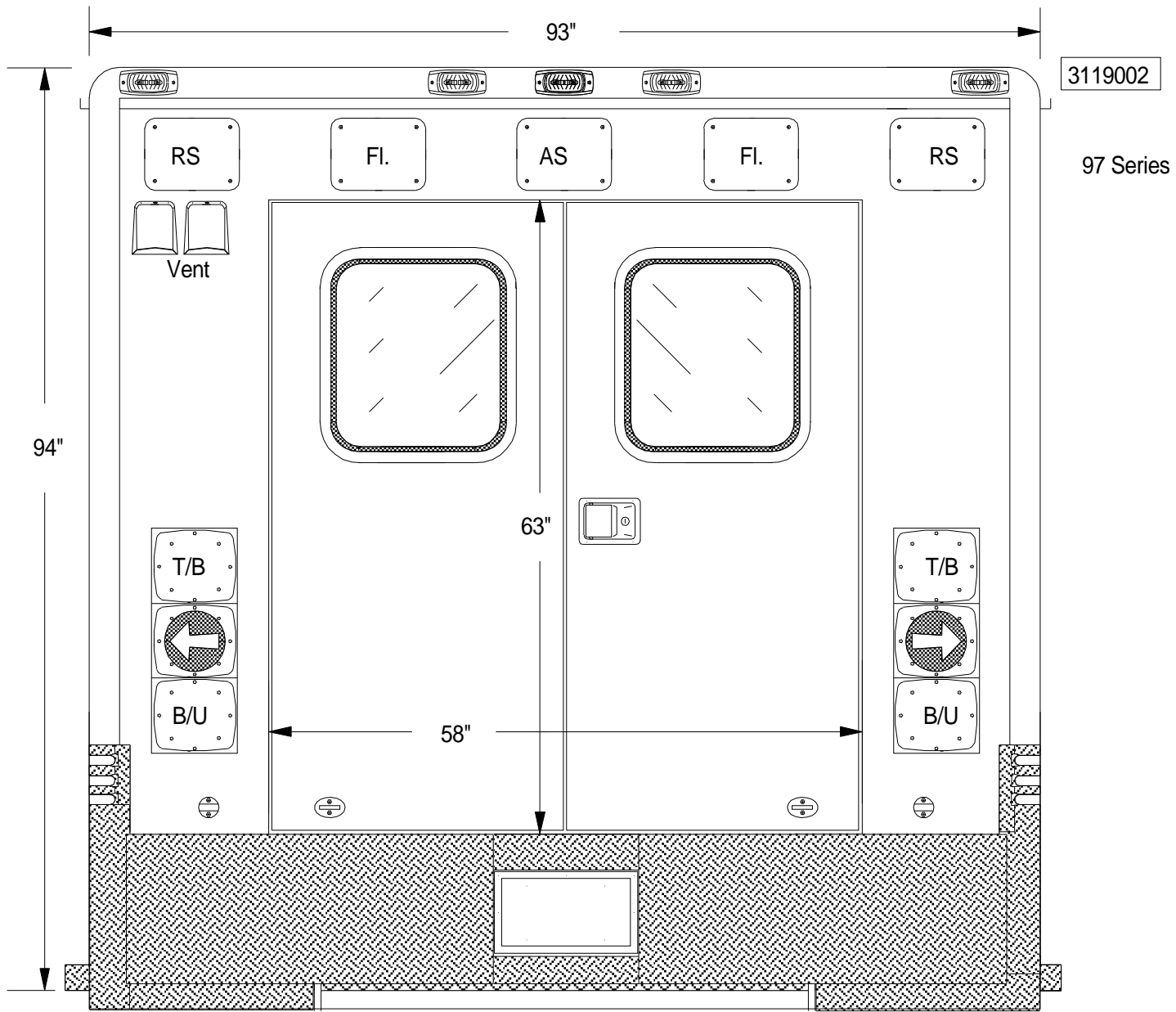

Mor-Ryde rear

Type I 1480	Date: 6/3/99
Body # 3119 -3123	
Marque Inc. - Goshen, IN	
Exterior View-Rear	

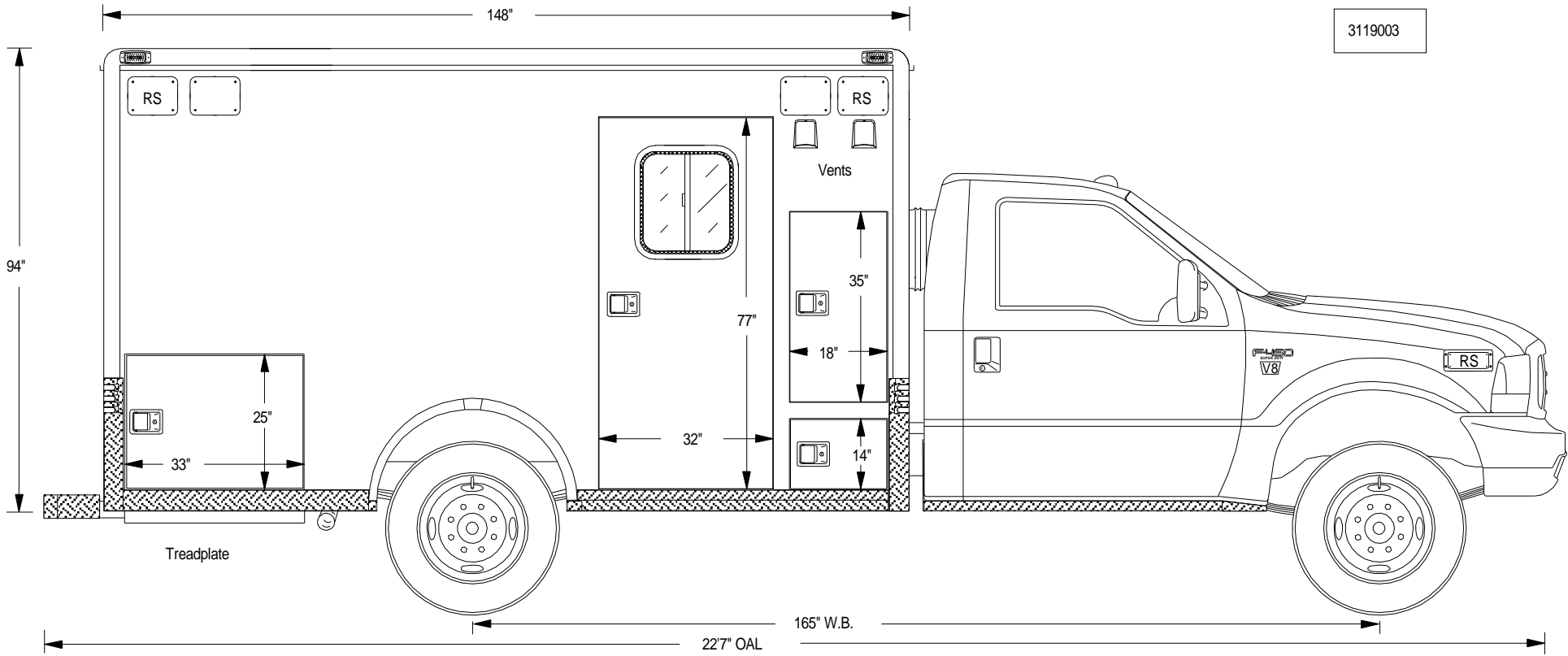

3119003

Marque Inc. Goshen, In.
Type I 1480
Body # 3119 -3123
Date: 6/3/99

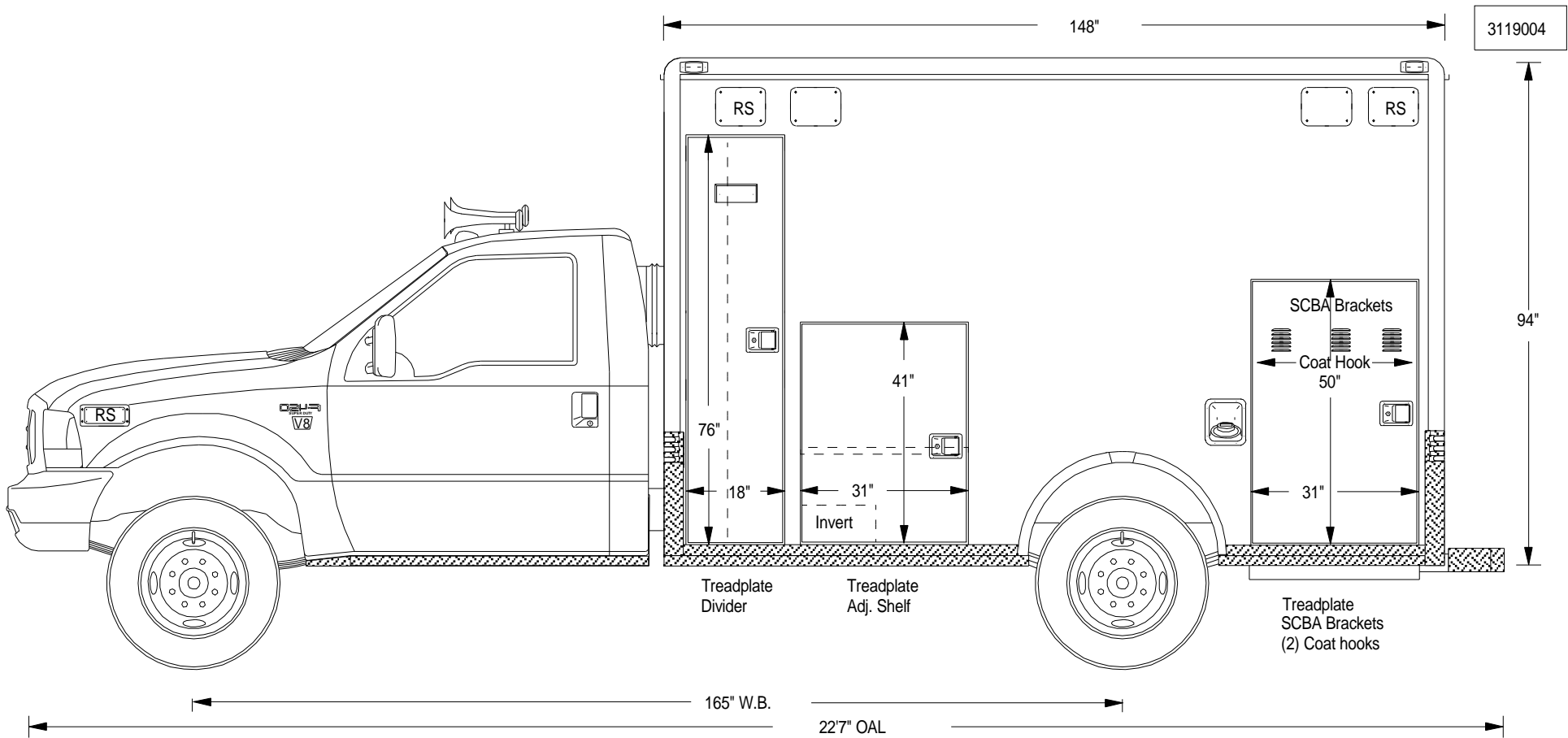

Marque Inc. Goshen, In.
Type I 1480
Body # 3119 -3123
Date: 6/3/99

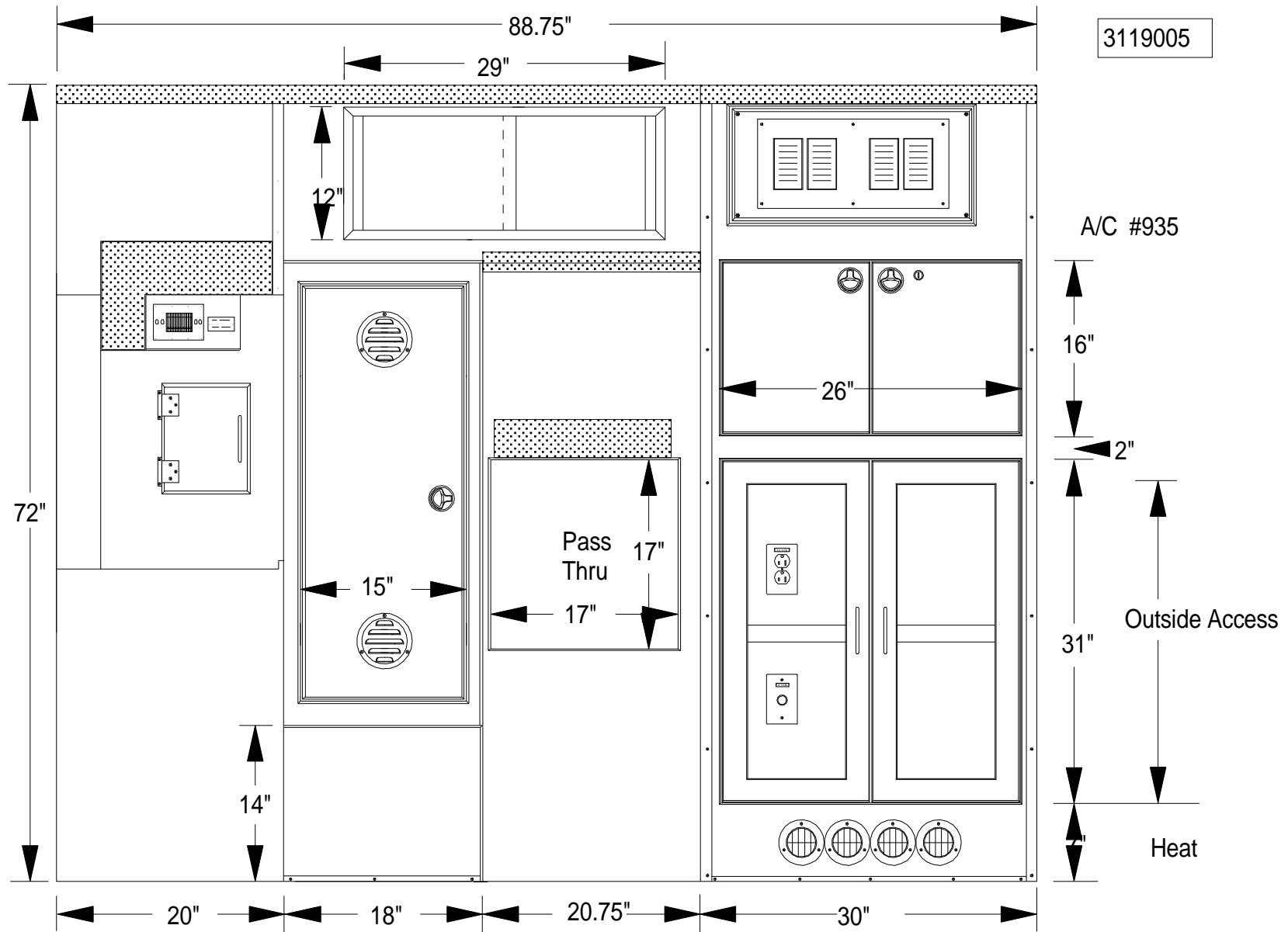

Marque Inc. Goshen, In.
Type I 1480
Body # 3119 -3123
Date: 6/3/99

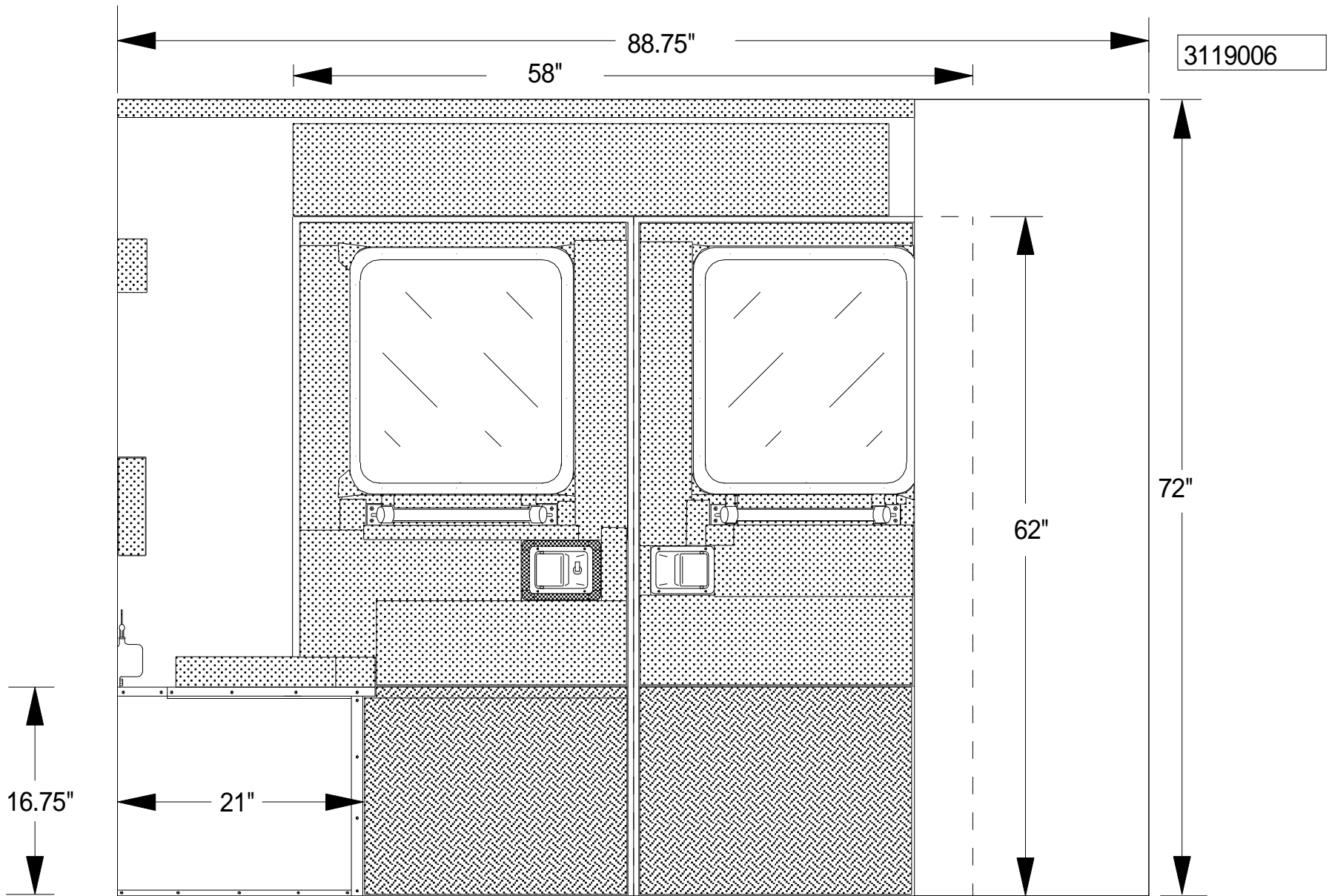

Type I 1480	
Body # 3119 -3123	
Marque, Inc - Goshen, IN	
Interior View-Rear	Date: 6/3/99

3119007

143.5"

72"

A/C

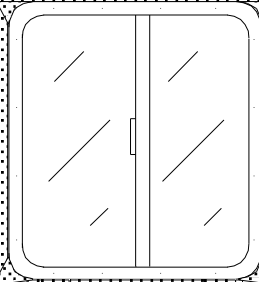
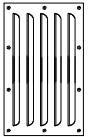

21.25"

Heat

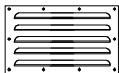

Full Roll Floor

88"

Type I 1480

Date: 6/3/99

Body # 3119 - 3123

Marque, Inc. - Goshen, IN

Interior View-Curb Side

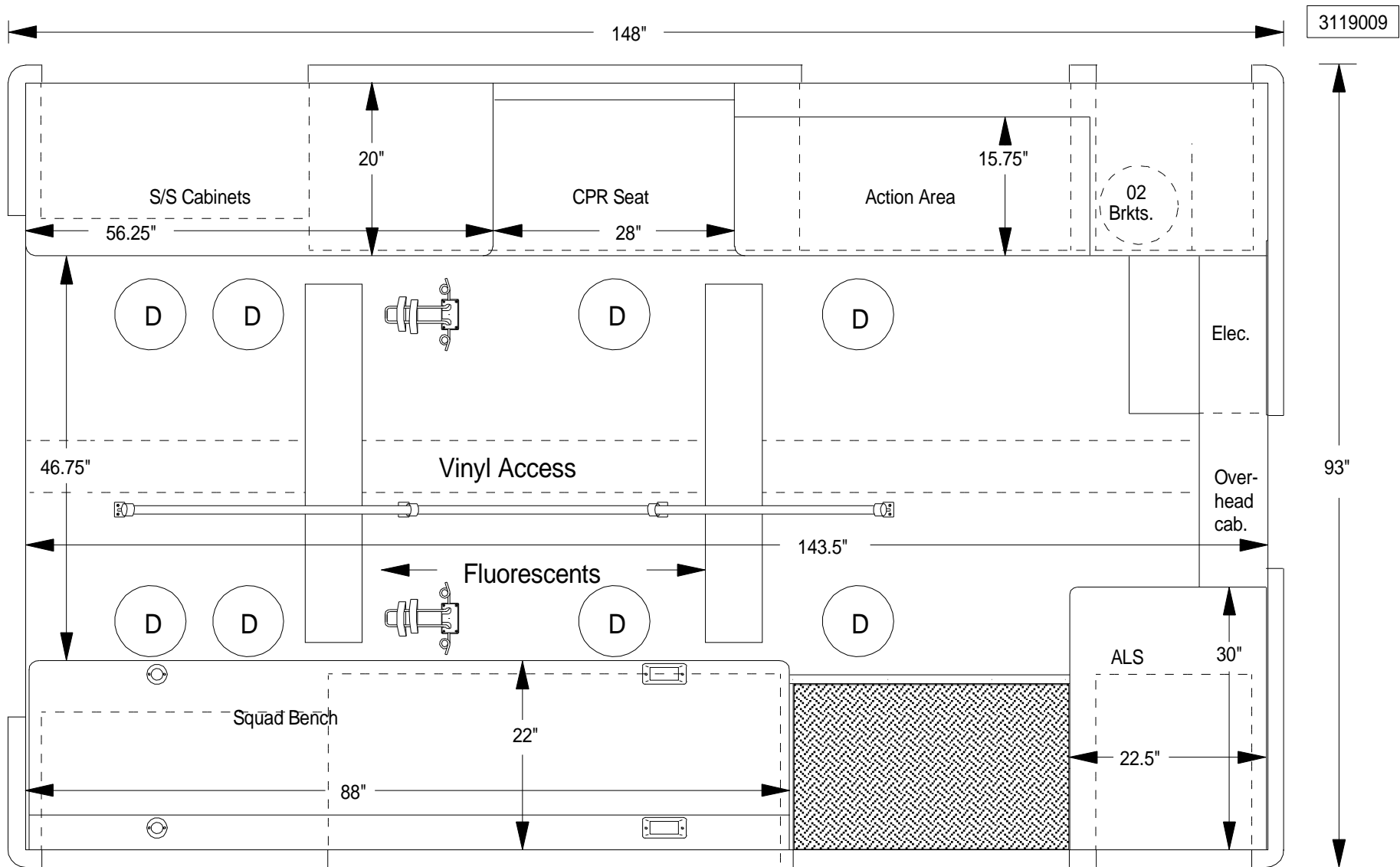

Marque Inc. Goshen, In.
Type I 1480
Body # 3119 - 3123
Date: 6/3/99